

## DUPLICATOR TAPE HEADS

CONFIDENTIAL REPLACEMENT HEAD CONVERSION LIST

MFR.	MODEL #	TRACK STYLE	Replacement Part Number		
			Record	Play	Erase
International Audio	Alpha 2000M	2T Mono C-C	5220	5222	
	Alpha 2000S	2T Mono C-C	5220		
	Alpha 4000M	4T Stereo C-C	5417	5419	
	Alpha 4000S	4T Stereo C-C	5417		
Magnefax	LB72	2T 1/4" B-C	5220D	8611D	
	LB74	4T 1/4" B-C	5414D		
	Solid State	FT 1/4" R-R	9104/D	2608D	
	Solid State	2T CAS R-R	5220/D	8210	
	Solid State	2T 1/4" R-R	9204/D	9206/D	
	Solid State	4T CAS R-R	5414/D	8610(2)	
	Solid State	4T 1/4" R-R	5607	5606	
	Tube Types	FT 1/4" R-R	9103/D	2608D	
	Tubes	2T 1/4" R-R	9203/D	9206/D	
	Tubes	4T 1/4" R-R	5607	5606	
	651	FT 1/4" R-R	9104D	2608D	
	652	2T 1/4" R-R	9204D		
	652-1	FT 1/4" R-R	9104D	2608D	
	652/652-1	2T 1/4" R-R		9206D	
	7574	4T 1/4" B-C	5414D	8611D(2)	
7575	4T 1/2" B-C	5414D	Not Avail.		
Pentagon	C-1	2T C-C	5201	5221	
	C-100	2T C-C	5201	5221	
	C-1000	2T 1/4" R-C	5201	9210	
	C-120	2T C-C	5201	5205	
	C-1320/23	2T 1/4" R/C-C		9210	
	C-1320/23	2T 1/4" R/C-C (C)	5201	5205	
	C-1320/23	2T 1/4" R/C-C (R)	9203		
	C-1343/1400	4T 1/4" RR-CC (C)	5411	5413	
	C-1343/1400	4T 1/4" RR-CC (R)	5604	5606	
	C-140	4T C-C	5411	5413	
	C-20	2T C-C	5201	5221	
	C-20Cr	2T C-C	5201	5221	
	C-32	2T C-C	5201	5221	
	C-320	2T C-C	5201	5221	

# DUPLICATOR TAPE HEADS (cont.)

MFR.	MODEL #	TRACK STYLE	Replacement Part Number		
			Record	Play	Erase
<b>Pentagon</b> (Continued)	C-34	4T C-C	5411	5413	
	C-340/400/420	4T C-C	5411	5413	
	C-4	4T C-C	5411	5413	
	C-4322/4422	2T C-C	5201	5221	
	C-8	8T 1/4"	5845/46	5847/48	
	CC/CS-1120	2T C-C	5201	5221	
	CC/CS-1140	4T C-C	5411	5413	
	CM-1200	2T C MAS		5205	
	CM-1400	4T C MAS		5413	
	CM-2000	2T C MAS		5205	
	CM-400	4T C MAS		5413	
	CM270/CS271	2T C-C	5201	5221	
	CS-420	2T C SL	5201		
	CS-440	4T C SL	5411		
	C5400	4T 1/2" R-C	5411	9468	
	RC-1120	2T 1/4" R-C	5201	9210	
	RC-1140	4T 1/4" R-C	5411	5606	
	RCC-1120	2T 1/4" RC-C	5201	9210 & 5221	
	RCC-1140	4T 1/4" RC-C	5411	5606 & 5413	
	RM/RS-1120	2T 1/4" RM-RS	9203	9210	
	RM/RS-1140	4T 1/4" RM-RS	5604	5606	
	RM/RS-1200	1/4" RM-.15" RS	5201	9210	
	RM/RS-1400	1/4" RM-.15" RS	5411	5606	
	RME/RS-2210	1/4" RM-.15" RS	5201	9210	
	RME/RS-2410	1/4" RM-.15" RS	5604	5606	
	RME/RS-2810	8T 1/4" RM-RS	5841	5840	
	RMT-2250	2T 1/4" R-R	9203	9210	
	RMT-4250	4T 1/4" R-R	5604	5606	
	S-1000	2T C SL	5201		
	S-140	4T C SL	5411		
	S-1400	4T C SL	5411		
	SCC-2150	2T C-C	5201	5205	
	SCC-4150	4T C-C	5411	5413	
	SRCC-2250	2T 1/4" R/CM-C	5201	5205 & 9210	
SRCC-4250	2T 1/4" R/CM-C	5411	5413 & 5606		
<b>Recordex</b>		2C4T 1/4"		8610	
	Courier II	CS 2C2T C-C	5220	5205	5214
	CS-200	CS 2C2T C-C	5201	5206	
	CS-2000	CS 2C2T C-C	5201	5206	
	CS-203	CS 2C2T C-C	5201	5205	5214
	CS-2500	CS 2C2T C-C	5201	5205	5214
	CS-4000	CS4C4T C-C	5411	5410	

TEL. 973-579-5773 • FAX 973-579-6021 • email [jrf@jrfmagnetics.com](mailto:jrf@jrfmagnetics.com)

**DUPLICATOR TAPE HEADS (cont.)**

MFR.	MODEL #	TRACK STYLE	Replacement Part Number		
			Record	Play	Erase
Recordex (Continued)	CS-403	CS 4C4T C-C	5411	5413	5214
	Dup I	CS 4C4T C-C	5411	5413	5214
	Dup II	CS 2C2T C-C	5220	5205	5214
	GT 2A	2C4T 1/4" RM		9206	
	GT 2AS	2C2T 1/4" RS	9204		
	GT 4A	2C4T 1/4' RM		8610	
	Mini Max Stereo	CS 4C4T C-C	5411	5410	
	Super Pro 30	CS 2C2T C-C	5220	5205	5214
	Super Pro 30	CS 4C4T C-C	5411	5413	5214
	315 Series II	CS 4C4T C-C	5411	5410	5214
	330 Series II	CS 2C2T C-C	5220D	5205D	5214
	345 Series II	CS 2C2T	5220D	5205D	
	515 AV Stereo	CS 4C4T C-C	5411	5410	
	530 AV Mono	C2 2C2T	5220D	5204	
Telex	CD2M & MS & S	2CH2T CM-CS	5229	5228	
	CD4M & MS & S	4CH4T CM-CS	5429	5428	
	Copier I & II	2CH2T CM-CS	5224D	5223	5214
	Copier IV & V	4CH4T CM-CS	5414D	5416	5214
	Copyette II Mono	2CH2TR CM-CS	5226	5227	
	Copyette II Stereo	4CH4T CM-CS	5426	5427	
	Copyette Stereo	4CH4T CM-CS	5417	5419	
	Copyette 1 & 1/3	2CH2T CM-CS	5220/D	5222	
	235 & 300	2CH2T CM-CS	5201D	5206	
	235 & 300	2CH2T RM-CS	5201 D	9210	
	235 & 300	2CH2T RM-RS	9203	9210	
	235 & 300	2CH4T RM-RS	8604	8610	
	235 & 300	4CH4T CM-CS	5411D	5413D	
	235 & 300	4CH4T RM-CS	5411D	8610	
	235 & 300	4CH4T RM-RS	5604	5640	
	6120	2CH2T CM-CS	5224D	5223	
	6120	2CH2T RM-CS	5224D	2040	
	6120	2CH2T RM-RS	2041	2040	
	6120	4CH4T CM-CS	5414D	5418	
	6120	4CH4T RM-CS	5414D	5640	
6120	4CH4T RM-RS	5641	5640		
Wollensak (3M)	2750 AV	2CH2T CM		5205/D	
	2760 AV	2CH2T CS	5201/D		
	2770 AV	2CH2T CM		5221/D	
	2780 AV	2CH2T CS	5220/D		
	6030 AV	2CH2T RM-1/4"		9206/D	

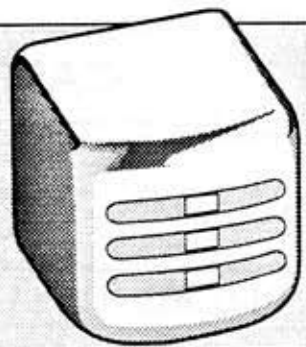

## CARTRIDGE RECORDER TAPE HEADS

### CONFIDENTIAL REPLACEMENT HEAD CONVERSION LIST

MODEL #	Mfr. Head No.	Head Function	Mount Type	Relacement Part Numbers		
				Original Head	Duracore	No Mount Conversion
<b>AMPRO (Instatape)</b>		NOTES: Play-only machines have no record head. Use 7605 for dummy record head.				
CT-2500, 3500, 4500, 5500 Series Mono	9086-1 9103-1	Record Program & Cue Play Program & Cue	No Mount	2010 2001	2010D 2001D	
CT-2500, 3500, 4500, 5500 Series Stereo	9085-1 9102-1	Record Program & Cue Play Program & Cue	No Mount	5710 5701	— 5701D	
<b>ATC (Gates)</b> (See also Harris)		NOTES: Play-only machines have no record head. Use 7605 for dummy record head. * Conversion to No Mount heads not recommended.				
Criterion CP11, CP112, CP13 Mono	20-1014 20-1011	Record Program & Cue Play Program & Cue	Rear Mount	2053 2057	2053 2057D	• •
Criterion CP11, CP12, CP13 Stereo	20-1016 20-1015	Record Program & Cue Play Program & Cue	Rear Mount	5753 5757	5753D —	• •
P150, P190, PB150, PB190, PC150, PC190 Mono	20-1001	Record/Play Program Record/Play & Cue	Rear Mount	2051 2050		2001 } 2000 } 114
<b>AUDI-CORD</b>		NOTES: *Play-only machines substitute dummy head for record head.				
100,101 Mono		Dummy Head* Play	No Mount	7605 2001	7605D 2001D	
105, 106 Stereo		Dummy Head* Play	No Mount	7605 5701	7605D 5701D	
110, 111 Mono		Record Play	No Mount	2003 2001	2003D 2001D	
115, 116 Stereo		Record Play	No Mount	5703 5701	5703D 5701D	
120, 121 Mono		Record Play	No Mount	2003 2001	2003D 2001D	
125, 126 Stereo		Record Play	No Mount	5703 5701	5703D 5701D	
130, 132, 134, 136 Network Delay		Play	No Mount	2000		



# CARTRIDGE TAPE HEADS (cont.)

MODEL #	Mfr. Head No.	Head Function	Mount Type	Relacement Part Numbers		
				Original Head	Duracore	No Mount Conversion
<b>AUDI-CORD (Cont.)</b>		NOTES: Play-only machines substitute dummy head for record head.				
131, 133, 135, 137 Delay	P-A2H44R	Erase/Record Play	No Mount	6101 2001	2001D	
140, 141 Mono		Play	No Mount	2001	2001D	
145, 146 Stereo		Play	No Mount	5701	5701D	
127 4-Chan.		Record Play	No Mount	5601 5603		
<b>BEUCART (UMC Electronics)</b>		NOTES: *Play-only machines substitute dummy head for record head.				
11-X1X-XXX Mono	BH-1001 BH-3001	Dummy Head* Play	No Mount	7506 2001	7605D 2001D	
11-X2X-XXX Stereo	BH-1001 BH-5001	Dummy Head* Play	No Mount	7605 5701	7605D 5701D	
12-X1X-XXX Mono	BH-2001 BH-3001	Record Play	No Mount	2003 2001	2003D 2001D	
12-X2X-XXX Stereo	BH-4001 BH-5001	Record Play	No Mount	5703 5701	5703D 5701D	
13-X1X-XXX Mono	BH-1001 BH-3001	Dummy Head* Play	No Mount	7605 2001	7605D 2001D	
13-X2X-XXX Stereo	BH-1001 BH-5001	Dummy Head* Play	No Mount	7605 5701	7605D 5701D	
14-X1X-XXX Mono	BH-2001 BH-3001	Record Play	No Mount	2003 2001	2003D 2001D	
14-X2X-XXX Stereo	BH-4001 BH-5001	Record Play	No Mount	5703 5701	5703D 5701D	
21-X1X-XXX Mono	BH-1001 BH-3001	Dummy Head* Play	No Mount	7605 2001	7605D 2001D	
21-X2X-XXX Stereo	BH-1001 BH-5001	Dummy Head* Play	No Mount	7605 5701	7605D 5701D	
22-X1X-XXX Mono	BH-2001 BH-3001	Record Play	No Mount	2003 2001	2003D 2001D	

TEL. 973-579-5773 • FAX 973-579-6021 • email [jrf@jrfgmagnetics.com](mailto:jrf@jrfgmagnetics.com)





# CARTRIDGE TAPE HEADS (cont.)

MODEL #	Mfr. Head No.	Head Function	Mount Type	Relacement Part Numbers			
				Original Head	Duracore	No Mount Conversion	
<b>MACARTA (See SMC)</b>							
<b>PACIFIC RECORDERS</b>							
Tom Cat	Stereo		Record, Program & Cue Play, Program & Cue	No Mount	5900 5901		
<b>RAMCO RESEARCH</b>							
RPS-1	Stereo		Play Record	No Mount	- -	5730D 5715D	
PS-1	Stereo		Play	No Mount	- -	5730D	
Primus	Mono		Play Record	No Mount	-	2030D	
	Stereo		Play Record			2010D 5730D 5715D	
<b>RCA</b>	NOTES: 1. Program head is next to the capstan. 2. NAB monitor conversion of RT-7 series to two-channel heads is described in Nortronics form #7407. Order a copy from Nortronics. Different heads are specified from those on this sheet. 3. Quik-Kit conversion to No-Mount heads is not recommended. 4. Play-only machines have no record head. Use #7605 for dummy head, (No Mount) or 7655 (Rear Mount). 5. "A" Series takes different record head from older "non-A" machines.						
RT-7A <sup>2</sup>	Mono	223320 223320	Record/Play Program <sup>4</sup> Record/Play Cue	Rear Mount	2051 2051		2001 } 114 <sup>2</sup> 2001 }
RT-7B, RT-7C, RT-7D <sup>2</sup>	Mono	226517 223320	Record/Play Program <sup>4</sup> Record/Play Cue	Rear Mount	2052 2051		2002 } 114 <sup>2</sup> 2001 }
RT-8, RT-17, RT-27, RT-37	Mono	231290 231290	Record Program & Cue <sup>4</sup> Play Program & Cue	Rear Mount	2052 2052	2052D 2052D	Note 3.
RT-8, RT-17, RT-27, RT-37	Stereo	231289 231289	Record Program & Cue <sup>4</sup> Play Program & Cue	Rear Mount	5752 5752		Note 3.
RT-125, RT-126, RT-127	Mono	Note 5.	Record Program & Cue <sup>4</sup> Play Program & Cue	No Mount	2010 2001	2010D 2001D	
RT-125, RT-126, RT-127	Stereo	Note 5.	Record Program & Cue <sup>4</sup> Play Program & Cue	No Mount	5710 5701	5701D	
RT-125A, RT-126A, RT-127A	Mono	Note 5.	Record Program & Cue <sup>4</sup> Play Program & Cue	No Mount	2003 2001	2003D 2001D	
RT-125A, RT-126A, RT-127A	Stereo	Note 5.	Record Program & Cue <sup>4</sup> Play Program & Cue	No Mount	5703 5701	5703D 5701D	

TEL. 973-579-5773 • FAX 973-579-6021 • email [jrf@jrfmagnetics.com](mailto:jrf@jrfmagnetics.com)



# CARTRIDGE TAPE HEADS (cont.)

MODEL #	Mfr. Head No.	Head Function	Mount Type	Relacement Part Numbers		
				Original Head	Duracore	No Mount Conversion
<b>SCHAFFER (Cetec)</b>		NOTES: Play-only machines have no record head. For dummy head use #7605				
Audiofile Mono	P-B2H4R P-B2H7K	Record-Program & Cue Play-Program & Cue	No Mount	2003 2001	2003D 2001D	
Audifile Stereo	P-B3Q4R P-B3Q7K	Record-Program & Cue Play-Program & Cue	No Mount	5703 5701	5703D 5701D	
<b>SMC (Macarta) (Sono-Mag)</b>		NOTES: 1. QK-114 needed if machine has rear-mount heads. 2. Play-only machines have no record head. Use #7605 for dummy head.				
105/108 Mono	P-B2H7K-N P-B2H7K-N	Record/Play Program Record/Play Cue	No Mount	2001 2001	2001D 2001D	Notes 1, 2
208 4T Stereo	P-B2Q7K	Play Program	No Mount	8608		Notes 1, 2
245 & 248 & 250 Carousel, 500, 510 710, 721, 790 Caro-Stat, Mark II Mono	P-B2H2K	Play, Program & Cue	No Mount	2000		Notes 1, 2
245-2 & 248-2 & 252 Carousel, 502 512, 572, 712, 722, 792, Mark II Stereo	P-B3Q7K	Play, Program & Cue	No Mount	5701	5701D	Notes 1, 2
350 Carousel Mono	P-B2H2K-R P-B2H4R-R	Play, Program & Cue Record, Program & Cue	Rear Mount	2050 2053		2000 } QK114 2003 }
352 Carousel Stereo	P-B3Q7K P-B3Q4R	Play, Program & Cue Record, Program & Cue	Rear Mount	5751 5753		5701 } QK114 5703 }
560, 570, 590, 770, 790 Mono	P-B2H4R P-B2H7K	Record, Program & Cue Play, Program & Cue	No Mount	2003 2001	2003D 2001D	Note 1
572, 592, 772, 792 Stereo	P-B3Q4R P-B3Q7K	Record, Program & Cue Play, Program & Cue	No Mount	5703 5701	5703D 5701D	Note 1
593, 793 Delay Mono	P-A1HC44R P-B1HY2K	Erase/Record Program Play Program	No Mount	6126 2600		
2405/2408 Carousel Mono	P-B2H7K-N P-B2H7K-N	Play Program Play Cue	No Mount	2001		Notes 1, 2

TEL. 973-579-5773 • FAX 973-579-6021 • email [jrf@jrfgmagnetics.com](mailto:jrf@jrfgmagnetics.com)



# CARTRIDGE TAPE HEADS (cont.)

MODEL #	Mfr. Head No.	Head Function	Mount Type	Relacement Part Numbers		
				Original Head	Duracore	No Mount Conversion
<b>SPARTA (Cetec)</b>		NOTES: 1. Playback units take play head only. 2. Early units with rear mount heads need QK. 3. For dummy head use #7605				
CD 15-2 Delay	895-0030 895-0020	R/P/E (Combo Head) Play	No Mount	6127 2601		QK-114 <sup>2</sup> QK-114 <sup>2</sup>
BP11, BP22, BP22B, BP22C, CP-5, Play, Port. Mono	895-0024	Play-Program & Cue	Side Mount	2001+38		
200P, 200RP, 300P, 300RP Mono	895-0022 895-0022	Record/Play-Program Record/Play-Cue	Rear Mount	2051 2051		2001 } 2001 } 114
MC104, 300B, 300C, 400P, 400RP, 800P, 800RP, 4510, 4515, 4610, 4615, Century Mono	895-0010 895-0020	Record-Program & Cue Play-Program & Cue	No Mount	2003 2001 <sup>1</sup>	2003D 2001D	
MC204, 200P, 200RP, 600P, 600RP, 4520, 4620, 4625, Century Stereo	895-0040 895-0042	Record-Program & Cue Play-Program & Cue	No Mount	5703 5701 <sup>1</sup>	5703D 5701D	QK-114 <sup>2</sup> QK-114 <sup>2</sup>
<b>TAPECASTER</b> Older vacuum tube models will take the same heads listed.		NOTES: 1. Mono record and play heads are same type. 2. Play-only and stereo machines have dummy head in left position. 3. Either "R" (short stud) or "R6" (long stud) rear mount heads will fit 700 series. 4. Only "R6" (long stud) heads will fit X700 series and precision head bracket.				
600P, 600RP Mono	P-G1H7K-R G1H2K-R	Record/Play-Program Record/Play-Cue	Rear Mount	2051 2050		2001 } 2000 } QK114
700P, 700RP Mono	P-B2H7K-R <sup>3</sup> P-B2H7K-R6	Record & Play <sup>1,2</sup> (2 heads, same)	Rear Mount	2051 <sup>1</sup> or 2056		2001 <sup>1</sup> } 2001 } QK114
700PS, 700RPS Stereo	P-B3Q7K-R <sup>3</sup> P-B3Q7K-R6	R/P-Program & Cue <sup>2</sup> (1 head only) <sup>2</sup>	Rear Mount	5751		5701+114
X700P, X700RP Mono	P-B2H7K-R6 <sup>4</sup> P-B2H7K-R6	Record-Program & Cue Play-Program & Cue <sup>2</sup>	Rear Mount	2056 <sup>4</sup> 2056		
X700PS, X700RPS Stereo	P-B3Q7K-R6	R/P-Program & Cue <sup>2</sup> (1 head only)	Rear Mount	5754 <sup>4</sup>		

TEL. 973-579-5773 • FAX 973-579-6021 • email [jrf@jrsmagnetics.com](mailto:jrf@jrsmagnetics.com)





# CARTRIDGE TAPE HEADS (cont.)

MODEL #	Mfr. Head No.	Head Function	Mount Type	Relacement Part Numbers		
				Original Head	Duracore	No Mount Conversion

## TAPECASTER (Continued)

Older vacuum tube models will take the same heads listed.

- NOTES:
1. Mono record and play heads are same type.
  2. Play-only and stereo machines have dummy head in left position.
  3. Either "R" (short stud) or "R6" (long stud) rear mount heads will fit 700 series.
  4. Only "R6" (long stud) heads will fit X700 series and precision head bracket.

700RPD, X700RPD Delay	P-A2H47K-R6 <sup>4</sup> P-B2H7K-R6	Rec/Erase-Prog. & Cue Play-Program & Cue	Rear Mount	6152 2056		
Dummy Head <sup>2</sup> (used on Mono-play and on Stereo units)			Rear Mount	7655		
			No Mount	7605		

## TELEX/MAGNECORD

MC-P3	Mono	55748 55742	Play-Program & Cue Dummy Head	No Mount	2001D 7605D	2001D 7605D
MC-PR3	Mono	55747 55748	Record-Program & Cue Play-Program & Cue	No Mount	2003D 2001D	2003D 2001D
MC-PS3	Stereo	55746 55742	Play-Program & Cue Dummy Head	No Mount	5701D 7605D	5701D 7605D
MC-PRS3	Stereo	55745 55746	Record-Program & Cue Play-Program & Cue	No Mount	5703D 5701D	5703D 5701D

TEL. 973-579-5773 • FAX 973-579-6021 • email [jrf@jrfmagnetics.com](mailto:jrf@jrfmagnetics.com)

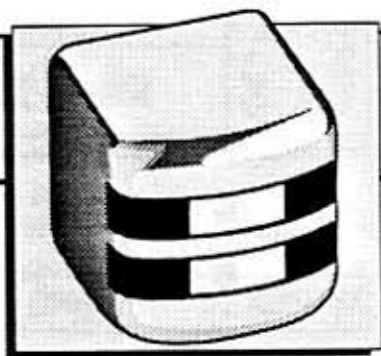

## REEL-TO-REEL TAPE HEADS

CONFIDENTIAL REPLACEMENT HEAD CONVERSION LIST

Model #	Track Style	Reference Notes	RP or RPE	4th Head or Combo	Record Head & QK	Playback Head & QK	Erase Head & QK
<b>AMPEX</b> NOTE: QK mounts needed first time only.							
A111	FT - 15				9103+86	9102+86	9125+86
A111	2TM - 17				8401+86	8400+86	9223+86
A111	2TS - 17				9203+86	9203+86	9223+86
A112	FT - 15				9103+86	9102+86	9125+86
A112	2TM - 17				8401+86	8400+86	9223+86
A112	2TS - 17				9203+86	9203+86	9223+86
A114	FT - 15				9103+86	9102+86	9125+86
A114	2TM - 17				8401+86	8400+86	9223+86
A114	2TS - 17				9203+86	9203+86	9223+86
A121	FT - 15				9103+86	9102+86	9125+86
A121	2TM - 17				8401+86	8400+86	9223+86
A121	2TS - 17				9203+86	9203+86	9223+86
A122	FT - 15				9103+86	9102+86	9125+86
A122	2TM - 17				8401+86	8400+86	9223+86
A122	2TS - 17				9203+86	9203+86	9223+86
A124	FT - 15				9103+86	9102+86	9125+86
A124	2TM - 17				8401+86	8400+86	9223+86
A124	2TS - 17				9203+86	9203+86	9223+86
AG300-1	FT - 14, 20				9104+76	9102+76	9127+76
AG300-2	2TS - 20				9204+76	9202+76	9222+76
AG300	4TS - 20				8614+76	8600+76	
AG300-4	4CH 1/2" - 17				9465	9464	9472
AG305-1	FT Play					9102+76	
AG305-2	2TS Play					9202+76	
AG305	4TS Play					8600+76	
AG305	4CH 1/4" Play					5603+76	
AG350-1	FT - 14, 20, 27	P 2T	8200+86	9104+76	9102+76	9127+76	
AG350-2	2TS - 20, 27	P 4TS	8600+86	9204+76	9202+76	9222+76	
AG350	4TS - 20, 27	P 2TS	9202+86	8614+76	8600+76		
AG355	FT	P 2T	8200+76		9102+76		
AG355	2TS	P 4TS	8600+76		9202+76		
AG440	FT - 23	P 2T	9209+76	9104+76	9109+76	9127+79	
AG440	2TS - 23	P 4TS	8609+76	9204+76	9209+76	9227+79	
AG440	4TS - 23	P 2TS	9209+76	8618+76	8609+76		
AG440	4CH 1/2" - 43			9465	9474	9472	
AG440B	FT - 23	P 2T	9209+76	9104+76	9109+76	9127+79	
AG440B	2TS - 23	P 4TS	8609+76	9204+76	9209+76	9227+79	
AG440B	4TS - 23	P 2TS	9209+76	8618+76	8609+76		
AG440B	4CH 1/2" - 43			9465	9474	9472	
AG440C	FT, 2T - 23	P 2T	9209+76	9104+76	9109+76	9127+79	



# Reel-to-Reel Tape Heads (cont.)

Model #	Track Style Reference Notes	RP or RPE	4th Head or Combo	Record Head & QK	Playback Head & QK	Erase Head & QK
<b>AMPEX (Continued)</b> NOTE: QK mounts needed first time only.						
AG440C	2TS - 23	P 4TS	8609+76	9204+76	9209+76	9227+79
AG440C	4TS - 23	P 2TS	9209+76	8618+76	8609+76	
AG440C	4CH 1/2" - 43			9465	9474	9472
AG445	FT	P 2T	9209+76		9109+76	
AG445	2TS	P 4TS	8609+76		9209+76	
AG445	4CH 1/4"				5605+76	
AG445B	FT	P 2T	9209+76		9109+76	
AG445B	2TS	P 4TS	8609+76		9209+76	
AG445B	4CH 1/4"				5605+76	
AG445C	FT	P 2T	9209+76		9109+76	
AG445C	2TS	P 4TS	8609+76		9209+76	
AG445C	4CH 1/4"				5605+76	
AG500	FT	P 2T	9207+87	9103+87	9111+87	9125+87
AG500	2TS - 21	P 4TS	8607+87	9203+87	9207+87	9227+87
AG500	4TS - 22	P 2TS	9207+87	8618+87	8607+87	
AG500	4CH 1/4" - 22, 30			5604+87	5603+87	9125+87
AG600	FT - 15			9103+86	9111+86	9125+86
AG600	2TM, 2TS - 21			9203+86	9207+86	9227+86
AG600	4TS - 22			8618+86	8607+86	
AG600B	FT - 15			9103+86	9111+86	9125+86
AG600B	2TM, 2TS - 21			9203+86	9207+86	9227+86
AG600B	4TS - 22			8618+86	8607+86	
AL500	2TS - 21	P 4TS	8607+87	9203+87	9207+87	9227+87
AL500	4TS - 22	P 2TS	9207+87	8618+87	8607+87	
AL500	4CH 1/4" - 22, 30			5604+87	5603+87	9125+87
ATR700	2TS			9203+85	9213+85	9226+66
ATR700	4TS			8604+85	8608+85	8701+66
ATR700	FT			9103+85	9119+85	9126+66
PR-10-1	FT - 15	P 2T	8400+87	9103+87	9102+87	9125+87
PR-10-1	2TM - 15			8401+87	8400+87	8504+87
PR-10-2	2TS - 17	P 4TS	8600+87	9203+87	9202+87	9223+87
PR-10-2	4TS - 15	P 2TS	9203+87	8618+87	8600+87	
300-1	FT			9103+76	9102+76	9125+76
300-2	2TS - 17			9203+76	9202+76	9223+76
300-2	4TS			8618+76	8600+76	8701+76
300-4	4CH 1/2" - 17			9465	9464	9472
350-1	FT			9103+76	9102+76	9125+76
350-2	2TS - 17			9203+76	9202+76	9223+76
350-2	4TS			8618+76	8600+76	8701+76
350-4	4CH 1/2" - 17			9465	9464	9472
351-1	FT			9103+76	9102+76	9125+76
351-2	2TS - 17			9203+76	9202+76	9223+76
351-2	4TS			8618+76	8600+76	8701+76
354-1	FT - 15			9103+76	9102+76	9125+76
354-2	2TS - 17			9203+76	9202+76	9223+76

TEL. 973-579-5773 • FAX 973-579-6021 • email [jrf@jrfmagnetics.com](mailto:jrf@jrfmagnetics.com)



# Reel-to-Reel Tape Heads (cont.)

Model #	Track Style — Reference Notes	RP or RPE	4th Head or Combo	Record Head & QK	Playback Head & QK	Erase Head & QK
<b>AMPEX (Continued)</b> NOTE: QK mounts needed first time only.						
354-2	4TS - 15			8618+76	8600+76	8640+76
400	FT			9103+76	9102+76	9125+76
400	2TS - 17			9203+76	9202+76	9223+76
401	FT			9103+76	9102+76	9125+76
401	2TS - 17			9203+76	9202+76	9223+76
450	2TS	P			9202+35	
450	4TS	P			8600+35	
600	FT - 15			9103+92	9102+92	9125+92
600	2TM - 17			8401+92	8400+92	9223+92
601	FT - 15			9103+92	9102+92	9125+92
601	2TM - 17			8401+92	8400+92	9223+92
601-2	2TS - 15			9203+92	9202+92	9223+92
602-1	FT - 15, 37			9103+86	9102+86	9125+86
602-2	2TS-17, 37			9203+86	9202+86	9223+86
602-1	2TM - 17, 37			8401+86	8400+86	9223+86
602-2	2TS - 17, 37			9203+86	9202+86	9223+86
900 Series	FT - 32, 15			9103+86	9102+86	9125+86
900 Series	2TM - 32, 15			8401+86	8400+86	9223+86
900 Series	2TS - 32, 17			9203+86	9202+86	9223+86
900 Series	4TS - 32, 15			8604+86	8600+86	8701+86
1200	2TS - 15			9203+86	9202+86	9222+86
1200	4TS - 15			8604+86	8608+86	
1250	2TS - 15			9203+86	9202+86	9222+86
<b>CUEMASTER (Consolidated Electronics CEPAC)</b>						
1250	4TS - 15			8604+86	8608+86	
MK III	FT			9103	9102	9129
MK IV	FT			9103	9102	9129
MK V	FT			9109	9119	8109
<b>CONCERTONE (Berlant)</b>						
MK V	2TS			9209	9213	8309
AV102	FT - 4			9111+106	9102+106	4400+304
AV102	2M - 4			8401+106	2600+106	3600+304
AV102	2S - 4			2003+106	2000+108	2200+304
AV102	4S - 4			1203+106	1200+106	1400+304
AV102	3C - 4, 11			5702+106	5701+106	8101+106
AV102	4C - 4, 11			5601+106	5603+106	8101+106
BA-1	FT			9105+106	9111+106	4400+304
BA-1	2M			8401+106	2600+206	3600+304
BA-1	2S			2003+106	2000+106	2200+304
BA-1	4S			1203+106	1200+106	1400+304
BA-1	3C - 4, 11			5702+106	5701+106	8101+106
BA-1	4C - 4, 11			5601+106	5603+106	8101+106
BAX	FT - 4			9105+106	9111+106	4400+304
BAX	2M			8401+106	2600+106	3600+304

TEL. 973-579-5773 • FAX 973-579-6021 • email [jrf@jrformagnetics.com](mailto:jrf@jrformagnetics.com)



## Reel-to-Reel Tape Heads (cont.)

Model #	Track Style — Reference Notes	RP or RPE	4th Head or Combo	Record Head & QK	Playback Head & QK	Erase Head & QK
<b>CONCERTONE (Berlant) (Continued)</b>						
BAX	2S			2003+106	2000+106	2200+304
BAX	4S			1203+106	1200+106	1400+304
BRX	FT			9105+106	9111+106	4400+304
BRX	2M			8401+106	2600+106	3600+304
BRX	2S			2003+106	2000+106	2200+304
BRX	4S			1203+106	1200+106	1400+304
BRXD5-5	FT			9105+106	9111+106	4400+304
BRXD5-5	2M - 4			8401+106	2600+106	3600+304
BRXD5-5	2S			2003+106	2000+106	2200+304
BRXD5-5	4S - 4			1203+106	1200+106	1400+304
BRX-P	FT - 4			9105+106	9111+106	4400+304
BRX-P	2M - 4			8401+106	2600+106	3600+304
BRX-P	2S - 4			2003+106	2000+106	2200+304
BRX-P	4S - 4			1203+106	1200+106	1400+304
BRX-1	FT			9105+106	9111+106	4400+304
BRX-1	2M			8401+106	2600+106	3600+304
BRX-1	2S			2003+106	2000+106	2200+304
BRX-1	4S			1203+106	1200+106	1400+304
C-540-IGM	2M				2601+84	NONE
MARK VII	FT			9105+106	9111+106	4400+304
MARK VII	2M			8401+106	2600+106	3600+304
MARK VII	2S			2003+106	2000+106	2200+304
MARK VII	4S			1203+106	1200+106	1400+304
MARK VII-C	2S			2003+106	2000+106	NSI
TWR	FT - 4			9105+106	9111+106	4400+304
TWR	2M - 4			8401+106	2600+106	3600+304
TWR	2S - 4			2003+106	2000+106	2200+304
TWR	4S - 4			1203+106	1200+106	1400+304
TWR-1	FT - 4			9105+106	9111+106	4400+304
TWR-1	2M - 4			8401+106	2600+106	3600+304
TWR-1	2S - 4			2003+106	2000+106	2200+304
TWR-1	4S - 4			1203+106	1200+106	1400+304
20/20 Series	FT - 4			9105+106	4000+106	4400+304
20/20 Series	2M			8401+106	2600+106	3600+304
20/20 Series	2S - 4			2003+106	2000+106	2200+304
20/20 Series	4S - 4			1203+106	1200+106	1400+304
30/30 Series	FT - 4			9105+106	9111+106	4400+304
30/30 Series	2M - 4			8401+106	8400+106	3600+304
30/30 Series	2S - 4			2003+106	2000+106	2200+304
30/30 Series	4S - 4			1203+106	1200+106	1400+304
33	2S			2003+106	2000+106	NONE
36-ST	FT - 4			9105+106	9111+106	4400+304
36-ST	2M - 4			8401+106	2600+106	3600+304
36-ST	2S - 4			2003+106	2000+106	2200+304
36-ST	4S - 4			1203+106	1200+106	1400+304

TEL. 973-579-5773 • FAX 973-579-6021 • email [jrf@jrfmagnetics.com](mailto:jrf@jrfmagnetics.com)





# Reel-to-Reel Tape Heads (cont.)

Model #	Track Style — Reference Notes	RP or RPE	4th Head or Combo	Record Head & QK	Playback Head & QK	Erase Head & QK
---------	-------------------------------	-----------	-------------------	------------------	--------------------	-----------------

## CONCERTONE (Berlant) (Continued)

60 Series	FT - 4			9105+106	9111+106	4400+304
60 Series	2M - 4			8401+106	2600+106	3600+304
60 Series	2S - 4			2003+106	2000+106	2200+304
60 Series	4S - 4			1203+106	1200+106	1400+304
60 Series	4C - 4, 11			5601+106	5603+106	8101+106
63-K	2S				2000+106	
91	2M			8401+84	2601+84	8506+84
92	2M			8401+84	2601+84	8506+84
93, -2, -2A	2S			2010+84	2000+84	8306+66
93, -2, -2A	4S - Trail Head				1200+84	
122	2M - 8	RP	3101+21			3601+18
216S	4S	RP	5232			NONE
240	2M	RP	5130			NONE
303	4S			8602+66	1202+66	1408+66
303D	4S			1203	1202	1408
400	NONE					
406D	4S	RP	5230			NONE
500	4S - 3			1210+84	1200+84	8708+84
505R	4S - 3			8614+84	8608+84	8708+66
605 Series	FT - 5			9103+66	9111+66	4402+19
605 Series	2M - 5			8401+66	2600+66	3602+19
605 Series	2S - 5			2010+66	2000+66	2202+19
605 Series	4S - 5			1210+66	1200+66	
700	2M - 2	RP	3002			NONE
727	4S - 8			1203+38	1207+38	1408+38
770	4S - 2, 8			1203	1207	1408+18
790	4S				1202+66	NSI
790	4S - 2			1203	1207	NONE
800	4S			1203+66	1201+66	1401+19
801	4S			1203+66	1201+66	1401+19
802	4S			1203+66	1201+66	1401+19
804	4S			1203+66	1201+66	1401+19
1033	FT - 15			9105+106	9111+106	4400+304
1033	2M - 4			2603+106	2600+106	3600+304
1033	2S - 4			2003+106	2000+106	2200+304

## CROWN INTERNATIONAL

1033	4S			1203+106	1200+106	1400+304
A-51	2M - L/R				8406+66	NONE
A-54	4S - L/R				8601+66	NONE
A-314	2M - L/R				8406+66	NONE
A-324	4S - L/R				8601+66	NONE
A-1314	2M - L/R				8406+66	NONE
B/C801	FT - 18			9103+66	9111+66	8104+66
B/C802	2M - 18			8404+66	8403+66	8304+66
B/C822	2S - 18			9205+66	9213+66	8304+66
B/C824	4S - 18			8603+66	8608+66	1401+19

TEL. 973-579-5773 • FAX 973-579-6021 • email [jrf@jrfmagnetics.com](mailto:jrf@jrfmagnetics.com)



## Reel-to-Reel Tape Heads (cont.)

Model #	Track Style — Reference Notes	RP or RPE	4th Head or Combo	Record Head & QK	Playback Head & QK	Erase Head & QK
<b>CROWN INTERNATIONAL (Continued)</b>						
BX801	FT			9103+66	9111+66	8104+66
BX802	2M			8404+66	8406+66	3601+18
BX822	2S - 19			9205+66	9213+66	9222+66
BX824	4S			8603+66	8601+66	1401+18
BX1024	4S			8603+66	8601+66	1401+18
BX1401	FT			9103+66	9111+66	8104+66
BX1402	2M			8404+66	8406+66	3601+18
BX1422	2S - 19			9205+66	9213+66	9222+66
CBD	2M - 19	RP	8403+66			8501+66
CBF	FT	RP	9111+66			8104+66
C1744	4T, 4C			5604+66	5603+66	1401+18
C1844	4C			5604+66	5603+66	1401+18
CID	2M - 9	RP	8403+66			8301+66
CIDS	2S	RP	8209+66			8301+66
CIF	FT	RP	9111+66			8104+66
CPDS	2S	RP	8209+66			8301+66
CPF	FT	RP	9111+66			8104+66
CR	2S	RP	8209+66			2201+18
CX711	FT			9103+66	9111+66	8104+66
CX712	2M			8404+66	8406+66	3601+19
CX722	2S - 19			9205+66	9213+66	9222+66
CX722-P4	2S, P4S	RE	6101+66	8601+66	8208+66	
CX724	4S			8603+66	8601+66	1401+18
CX724-P2	4S, P2S	RE	6004+66	8208+66	8601+66	
CX744	4T, 4C			5604+66	5603+66	1401+18
CX811	FT			9103+66	9111+66	8104+66
CX812	2M			8404+66	8406+66	3601+18
CX822	2S - 19			9205+66	9213+66	9222+66
CX822-P4	2S, P4S	RE	6101+66	8601+66	8208+66	
CX824	4S			8603+66	8601+66	1401+18
CX824-P2	4S, P2S	RE	6004+66	8208+66	8601+66	
CX844	4C			5604+66	5603+66	1401+18
SL724	4S	RE	6004+66		8600+66	
SL802	2M			8603+66	8600+66	3601+18
SL822	2S			9205+66	9213+66	2201+18
SL824	4S			8603+66	8600+66	1401+18
SP314	2M - L/R				8406+66	NONE
SP324	4S - L/R				8601+66	NONE
SP702	2M				8406+66	NONE
SP722	2S				9213+66	NONE
SP724	4S				8601+66	NONE
SP801	FT				9111+66	NONE
SP802	2M				8406+66	NONE
SP822	2S				9213+66	NONE
SP824	4S				8601+66	NONE

TEL. 973-579-5773 • FAX 973-579-6021 • email [jrf@jrfmagnetics.com](mailto:jrf@jrfmagnetics.com)



## Reel-to-Reel Tape Heads (cont.)

Model #	Track Style — Reference Notes	RP or RPE	4th Head or Combo	Record Head & QK	Playback Head & QK	Erase Head & QK
<b>CROWN INTERNATIONAL (Continued)</b>						
SS702	2M	RE	6126+66		8406+66	
SS722	2S	RE	6101+66		8208+66	
SS724	4S	RE	6004+66		8600+66	
SS801	FT			9103+66	9111+66	8104+66
SS802	2M - 19			8404+66	8406+66	3601+18
SS822	2S - 19			9205+66	9213+66	9222+66
SS824	4S			8603+66	8601+66	1401+18
SS1400	2S - 19			8204+66	8208+66	9222+66
SX701	FT			9103+66	9111+66	8104+66
SX702	2M			8404+66	8406+66	3601+18
SX711	FT			9103+66	9111+66	8104+66
SX712	2M			8404+66	8406+66	3601+18
SX722	2S - 19			9205+66	9213+66	9222+66
SX722-P4	2S, P4S	RE	6101+66	8601+66	8208+66	
SX724	4S			8603+66	8601+66	1401+18
SX724-P42	4S, P2S	RE	6004+66	8208+66	8601+66	
SX811	FT			9103+66	9111+66	8104+66
SX812	2M			8404+66	8406+66	3601+18
SX822-P4	2S, P4S	RE	6101+66	8601+66	8208+66	
SX824	4S			8603+66	8601+66	1401+18
SX824-P2	2S, P2S	RE	6004+66	8208+66	8601+66	
701-GCB	FT	RP	9111+66			8104+66
702-GCP	2M	RP	8403+66			3601+18
712-GCSX	2S - 19	RP	8209+66			9222+66
714C	4S	RP	6004+66			8601+66
752	2S	RP	8209+66			8304+38
800PK	FT			9103+66		
844	4CH			5604+66	5602+66	1401+18
844ST	4S	P			8601+66	
1001	FT			9103+66	9111+66	8104+66
1002	2M			8404+66	8403+66	3601+18
1022	2S - 19			9205+66	9213+66	9222+66
1024	4S			8603+66	8608+66	1401+18
1401	FT			9103+66	9111+66	8104+66
1402	2M			8404+66	8403+66	3601+18
1422	2S - 19			9205+66	9213+66	9222+66
1424	4S			8603+66	8601+66	1401+18
<b>ELECTRO SOUND</b>						
ES-505	FT 1/4"			9104+73	9102+73	9127+79
ES-505	2TM 1/4"			9204+73	9202+73	9227+79
ES-505	2TS 1/4"			9204+73	9202+73	9227+79
ES-505	4TS 1/4"			8614+73	8600+73	None
ES-505	4CH 1/4"			5607+73	5603+73	None

TEL. 973-579-5773 • FAX 973-579-6021 • email [jrf@jrfmagnetics.com](mailto:jrf@jrfmagnetics.com)



## Reel-to-Reel Tape Heads (cont.)

Model #	Track Style	Reference Notes	RP or RPE	4th Head or Combo	Record Head & QK	Playback Head & QK	Erase Head & QK
<b>ELECTRO SOUND</b>							
ES-505		4CH 1/2"					
ES-505		8CH 1"					
ES-555		FT 1/4"	P			9102+73	
ES-555		2TM 1/4"	P			9202+73	
ES-555		2TS 1/4"	P			9202+73	
ES-555		4TS 1/4"	P			8600+73	
ES-555		4CH 1/4"	P			5603+73	
<b>INTERNATIONAL TAPETRONICS (ITC)</b>							
855-0001		FT			9105	9119	9125
855-0002		FT			9105	9119	9125
855-0003		2TM			8404	8403	9226
855-0004		2TM			8404	8403	9226
855-0005		2TS			9205	9207	9226
855-0006		2TS			9205	9207	9226
855-0007		4TS			8603	8608	
855-0008		4TS			8603	8608	
856-0001		FT				9119	
856-0002		FT				9119	
856-0003		2TM				8403	
856-0004		2TM				8403	
856-0005		2TS				9207	
856-0006		2TS				9207	
856-0007		4TS				8608	
856-0008		4TS				8608	
855-7514	750	FT			9105	9119	9125
855-7515	Series	FT			9105	9119	9125
855-7524	"	2TM			8404	8403	9226
855-7525	"	2TM			8404	8403	9226
855-7534	"	2TS			9205	9207	9226
855-7535	"	2TS			9205	9207	9226
855-7544	"	4TS			8603	8608	
855-7545	"	4TS			8603	8608	
856-7514	"	FT				9119	
856-7515	"	FT				9119	
856-7524	"	2TM				8403	
856-7525	"	2TM				8403	
856-7532	"	2TS				8202	
856-7534	"	2TS				8202	
856-7535	"	2TS				8202	
856-7544	"	4TS				8608	
856-7545	"	4TS				8608	
770 Series		FT			9105	9119	9125
770 Series		2TS			8204D	8209	9226

TEL. 973-579-5773 • FAX 973-579-6021 • email [jrf@jrfmagnetics.com](mailto:jrf@jrfmagnetics.com)



# Reel-to-Reel Tape Heads (cont.)

Model #	Track Style	Reference Notes	RP or RPE	4th Head or Combo	Record Head & QK	Playback Head & QK	Erase Head & QK
<b>INTERNATIONAL TAPETRONICS (ITC) (continued)</b>							
770 Series		4TS			8603	8608	
750 Series		2TS			9205	9207	9226
855 Series		2TS			9205	9207	9226
856 Series		2TS			9205	9207	9226
<b>MAGNECORD (TELEX)</b>							
B358		NONE					
DMT Series		2S			9204	8202	
DST Series		2S			9204	8202	
F35B		NONE					
M30 Series		NONE					
M33		NONE					
M80, M90, P60, P75		FT			9103+35	9102+35	9127+35
M80, M90, P60, P75		2M			8401+35	8403+35	9227+35
M80, M90, P60, P75		2S			8201+35	8200+35	9227+35
M80, M90, P60, P75		4S			8604+35	8600+35	None
PT-6		NONE					
PT-63		NONE					
S35B		NONE					
S36B		NONE					
230L/1-R		2TM		3202	3203	3201	3601L
230L/4-R					5601	5603	1401L(2)
728		2S - 40	4S	8600+88	9204+88	9202+88	9228+88
748		4S - 40	2S	9202+88	8604+88	8600+88	
815, 16, 17		2M				8403+75	
815, 16, 17		4S				8608+75	
1020		4S	2S	8202	8602	8607	8702
1021		FT	2M	8406	9112	9111	8102
1022		2S	4S	8607	8203	8202	8302
1024		4S	2S	8202	8602	8607	8702
1028		2S - 40	4S	8600+88	9204+88	9202+88	9228+88
1048		4S - 40		9202+88	8604+88	8600+88	
1421F		FT	FT	9111	9112	8406	9128
1421H		2M			8404	8406	8302
1422H		2S	4S	8607	8203	8202	8302
1422Q		4S	2S	8202	8602	8607	8702
3000		FT	2M	8406	9112	9111	8101
3000		2TM			8404	8406	8301
3000		2TS	4S	8607	8203	8202	8301
3000		4TS	2S	8202	8602	8607	8702

TEL. 973-579-5773 • FAX 973-579-6021 • email [jrf@jrfmagnetics.com](mailto:jrf@jrfmagnetics.com)





# Reel-to-Reel Tape Heads (cont.)

Model #	Track Style	Reference Notes	RP or RPE	4th Head or Combo	Record Head & QK	Playback Head & QK	Erase Head & QK
<b>MCI</b>							
JH16		16CH 2"			9993	9994	9997
JH16-8		8CH 1"			9885	9886	9891
JH24		24CH 2"			9983	9984	9987
JH24-16		16CH 2"			9993	9994	9997
JH110		FT 1/4"			9104	9109	
JH110		2TS 1/4"			9204	9209	
JH110B & C		FT			9104	9110	
JH110B & C		2TS			9204	9211	
JH114-8		8CH 1"			9885	9886	
JH114-16		16CH 2"			9993	9994	
JH114-24		24CH 2"			9983	9984	
<b>METROTECH</b>							
400L		8T 1/4"			5833	5832	
514A		2TM	P			8209	
514P		2TM	P			8209	
516A		4CH, 4T	P			8601	
516LP		4CH, 4T	P			8601	
516P		4CH, 4T	P			8601	
523A		2TS	P			8209	
523P		2TS	P			8209	
525A		4TS	P			8601	
525P		4TS	P			8601	
526A		4TS	P			8601	
526LP		4TS	P			8601	
526P		4TS	P			8601	
527AL		4TS	P			8601	
527LP		4TS	P			8601	
531A		FT			9103	9119	4401
531R		FT			9103	9119	4401
533A		2TM			6104	8209	
533R		2TM			6104	8209	
534A		2TM			6104	8209	
534R		2TM			6104	8209	
543A		2TS			6104	8209	
543R		2TS			6104	8209	
545A		4TS			6007	8601	
545R		4TS			6007	8601	
546A		4TS			6007	8601	
546R		4TS			6007	8601	
547A		4TS			6007	8601	
547R		4TS			6007	8601	
552A		1CH, 4T			6007	8601	
552L		1CH, 4T			6007	8601	
554A		2CH, 4T			6007	8601	
554L		2CH, 4T			6007	8601	
555A		4CH, 4T			6007	8601	
555L		4CH, 4T			6007	8601	

TEL. 973-579-5773 • FAX 973-579-6021 • email [jrf@jrsmagnetics.com](mailto:jrf@jrsmagnetics.com)



# Reel-to-Reel Tape Heads (cont.)

Model #	Track Style — Reference Notes	RP or RPE	4th Head or Combo	Record Head & QK	Playback Head & QK	Erase Head & QK
<b>3M (See WOLLENSAK)</b>						
<b>MUZAK</b>						
Muzak	2TM - 44				8402+66	
<b>NEWCOMB</b>						
AV-70M	2S	RP	2050			2250
SM-310	2S	RP	2050			2250
SM-310-4	4S	RP	1250			1450
TX10-4	4S	RP	1250			1450
<b>OTARI</b>						
ARS-1000	2TS				9213+93	
Mark II-2	2TS			9203+93	9213+93	9227+93
Mark II-4	4CH 1/2"					
MTR-60	2TS			9203+93	9213+93	9227+93
MX-5050-FL	FTM	2T P	9213+93	9103+93	9119+93	NONE
MX-5050-2SH	2TS	4TS P	8608+93	9204+93	9207+93	NONE
MX-5050-QXHD	4CH 1/4"			5606+93	5603+93	NONE
MX-5050B	2TS	4TS P	8608+93	9204+93	9213+93	NONE
MX-5050B	FTM			9103+93	9119+93	NONE
MX-5050B	4CH 1/4"	2TS P	9213+93	5606+93	5603+93	NONE
MX-7000	2TS	4TS P	8608+93	9203+93	9213+93	9222+95
MX-7000	FTM			9103+93	9119+93	
<b>PIONEER</b>						
RT 701	4TS			8604+93	8608+93	NONE
RT 701	2TS - 42			9203+93	9213+93	9227+94
RT 701	FT - 42			9103+93	9119+93	9125+94
RT 707	4TS	4TS P	8608+93	8604+93	8608+93	NONE
RT 901	4TS			8604+93	8608+93	NONE
RT 901	2TS - 42			9203+93	9213+93	9222+94
RT 901	FT - 42			9103+93	9119+93	9126+94
RT 909	4TS	4TS P	8608+93	8604+93	8608+93	NONE
RT 1020	4TS - 42			8604+96	5603+96	8641+95
RT 1020	2TS - 42			9203+96	9207+96	9227+95
RT 1050	2TS			9203+96	9213+96	9223+95
RT 1051	4TS - 42			8604+96	5603+96	8641+95
RT 1051	2TS - 42			9203+96	9207+96	9227+95
RT 2022	2TS			9203+96	9207+96	9227+95
RT 2022	FT			9103+96	9111+96	9127+95
RT 2044	4CH			5604+96	5603+96	NONE

TEL. 973-579-5773 • FAX 973-579-6021 • email [jrf@jrsmagnetics.com](mailto:jrf@jrsmagnetics.com)



# Reel-to-Reel Tape Heads (cont.)

Model #	Track Style — Reference Notes	RP or RPE	4th Head or Combo	Record Head & QK	Playback Head & QK	Erase Head & QK
<b>PRESTO</b>						
CDR	2M				8403+35	
PB-17	2M				8403+35	
PT-900	FT			9103+35	9106+35	9125+35
PT-900	2M			8401+35	8402+35	8301+35
RC-10	FT			9103+35	9106+35	8106+35
RC-10	2M			8401+35	8402+35	8301+35
RC-24	FT			9103+35	9106+35	9125+35
RC-24	2M			8401+35	8402+35	8301+35
RD175	2M				8400+38	8301+38
625	2S				8208+35	
625	4S				8601+35	
800	FT			9103+35	9111+35	8102+35
800	2M			8401+35	8406+35	8302+35
800	2S			8201+35	8208+35	8302+35
800	4S			8604+35	8601+35	8702+35
825	FT			9103+35	9111+35	8102+35
825	2M			8401+35	8406+35	8302+35
825	2S			8201+35	8208+35	8302+35
825	4S			8604+35	8601+35	8702+35
850	FT			9103+35	9111+35	8102+35
850	2M			8401+35	8406+35	8302+35
850	2S			8201+35	8208+35	8302+35
850	4S			8604+35	8601+35	8702+35
<b>RCA</b>						
RT-19 Log.	4CH, 4T			6007	8601	
RT-21	FT			9107	9108	8110
RT-21	2TS			8206	8205	8307
RT-22	2T R-Cart.			2002	2002	8307
TP-66	16-mm				4951	
<b>REVOX</b>						
A-67	2TS			9203+97	9207+97	9227+95
A-67	FT			9103+97	9111+97	9127+95
A-67	4TS			8604+97	8607+97	NONE
A-77	2TS			9203+97	9207+97	NONE
A-77	FT			9103+97	9111+97	NONE
A-77	4TS			8604+97	8607+97	NONE
A-700	2TS			9204+97	9211+97	9227+95
A-700	FT			9104+97	9110+97	9127+95
B-77	2TS			9203+97	9211+97	9227+95
B-77	FT			9103+97	9111+97	9127+95

TEL. 973-579-5773 • FAX 973-579-6021 • email [jrf@jrfmagnetics.com](mailto:jrf@jrfmagnetics.com)



# Reel-to-Reel Tape Heads (cont.)

Model #	Track Style	Reference Notes	RP or RPE	4th Head or Combo	Record Head & QK	Playback Head & QK	Erase Head & QK
<b>REVOX (Continued)</b>							
B-77		4TS			8604+97	8607+97	NONE
PR-99		2TS			9203+97	9207+97	9227+95
PR-99		FT			9103+97	9111+97	9127+95
PR-99		4TS			8604+97	8607+97	NONE
D36, E36, F36, G36		FT - 35			9103+87	9102+87	
D36, E36, F36, G36		2S - 35			9203+87	9202+87	
D36, E36, F36, G36		4S - 35			8604+87	8600+87	
<b>SCHAFFER (See also Cart Section))</b>							
AL-330					1222	1221	
VLR Logger					1222	8601	
<b>SCULLY/METROTECH (Dictaphone)</b>							
100-8		8CH 1" - 38	RPE	9887 RPE	9888 RP		9892 E
100-16		16CH 2" - 38	RPE	9998 RPE	9995 RP		9999 E
250-FT		FTM 1/4"			9104	9110	9128
250-1		2TM 1/4"			8207	8202	9223
250-2		2TS 1/4"			8207	8202	9223
250-24		4TS 1/4"			8618	8607	8641
255-FT		FTM 1/4"	P			9110	
255-1		2TM 1/4"	P			8202	
255-2		2TS 1/4"	P			8202	
255-24		4TS 1/4"	P			8607	
270		FT 1/4" - 16	P			9102+91	
270-1		2TM 1/4" - 16	P			9202+91	
270-2		2TS 1/4" - 16	P			9202+91	
270-24		4TS 1/4" - 16	P			8600+91	
270-44		4TS 1/4" - 39	P			5603+91	
275		FT 1/4" - 16	P			9102+91	
275-1		2TM 1/4" - 16	P			9202+91	
275-2		2TS 1/4" - 16	P			9202+91	
275-24		4TS 1/4" - 16	P			8600+91	
275-44		4TS 1/4" - 39	P			5603+91	
280		FTM 1/4" - 16			9104+91	9102+91	9128+91
280-1		2TM 1/4" - 16			9204+91	9202+91	9223+91
280-2		2TS 1/4" - 16			9204+91	9202+91	9223+91
280-4		4TS 1/4" - 16			8618+91	8600+91	8641+91
280-44		4CH 1/4"			5607+91	5603+91	1402(2)
280B-FT		FTM 1/4"			9104+91	9110+91	9128+91
280B-1		2TM 1/4"			9209+91	9211+91	9223+91
280B-2		2TS 1/4"			9209+91	9211+91	9223+91
280B-24		4TS 1/4"			8618+91	8606+91	8641+91
280B44		4CH 1/4"			5607+91	5602+91	

TEL. 973-579-5773 • FAX 973-579-6021 • email [jrf@jrsmagnetics.com](mailto:jrf@jrsmagnetics.com)



# Reel-to-Reel Tape Heads (cont.)

Model #	Track Style	Reference Notes	RP or RPE	4th Head or Combo	Record Head & QK	Playback Head & QK	Erase Head & QK
<b>SCULLY/METROTECH (Dictaphone) (Continued)</b>							
282-3		3CH 1/2"			9361	9360	9370
282-4		4CH 1/2"			9461	9460	9470
284-8		8CH 1"			9881	9880	9890
284B-FT		FTM 1/4"			9104+91	9102+91	9128+91
284B-1		2TM 1/4"			9209+91	9211+91	9223+91
284B-2		2TS 1/4"			9209+91	9211+91	9223+91
284B-4		4CH 1/2"			9469	9476	9470
284B-24		2TS 1/4"			8618+91	8606+91	8641+91
284B-44		4CH 1/4"			5607+91	5602+91	
284B-8		8CH 1"			9882	9889	9890
285B-FT		FTM 1/4"			9104+91	9102+91	9128+91
285B-2		2TS 1/4"			9209+91	9211+91	9223+91
285B-24		4TS 1/4"			8618+91	8606+91	8641+91
288-8		8CH 1"			9881	9880	9890
288-12		12CH 1"			9981	9980	9986
288-16		16CH 2"			9992	9990	9996

## L. J. SCULLY

LJ-10	2TM	P				9202	
LJ-10	2TS	P				9202	
LJ-10	4TS	P				8600	

## STANCIL-HOFFMAN

R70/ARP76	FT				9105	9111	9125
R70/ARP76	2TM				8404	8403	8304
R70/ARP76	2TS				9205	9213	9226
R70/ARP76	4TS				8603	8608	8701
R70/ARP76	4CH				5601	5603	

## TAPE-ATHON

CT-1, CT375, 720	2TM				Pair Heads	7405L 7404U	
720, 800	4TM/S					1201+66	
900	FT				9103+66	9119+66	9125+66
900-1	2TM				8401+66	8403+66	9222+66
900-2	2TS				9203+66	9213+66	9222+66
900-4	4TS				8604+66	8608+66	8701+66
900-L2	2T				9203+66	9213+66	9222+66
900-L2-8	8T 2CH				5832+66	5832+66	
900-L4	4T				8604+66	8608+66	8701+66
900-L4-4	4T				8604+66	8608+66	8701+66
900-L4-8	8T 4CH				5832+66	5832+66	
900-L8	8T				5832+66	5832+66	
900-L8-8	8T				5832+66	5832+66	
1000	FT				9103+66	9119+66	9125+66
1400	FT				9103+66	9119+66	9125+66

TEL. 973-579-5773 • FAX 973-579-6021 • email [jrf@jrsmagnetics.com](mailto:jrf@jrsmagnetics.com)





# Reel-to-Reel Tape Heads (cont.)

Model #	Track Style	Reference Notes	RP or RPE	4th Head or Combo	Record Head & QK	Playback Head & QK	Erase Head & QK
<b>TEAC</b>							
A-7030	FT				9103+85	9119+85	9126+66
A-7030	2TS				9203+85	9213+85	9226+66
TCA40	4CH				5604+85	5603+85	
TCA41	4CH				5604+85	5603+85	
TCA42	4CH				5604+85	5603+85	
25-2	2TS		4TS P	8608+85	9203+85	9213+85	NSI
105	FT				9103+85	9119+85	9127+66
105	2TS				9203+85	9213+85	9227+66
105	4TS				8604+85	8608+85	NONE
110	FT				9103+85	9119+85	9127+66
110	2TS				9203+85	9213+85	9227+66
110	4TS				8604+85	8608+85	NONE
200	4CH				5604+85	5603+85	
310	FT				9103+85	9119+85	9127+66
310	2TS				9203+85	9213+85	9227+66
310	4TS				8604+85	8608+85	NONE
340	FT				9103+85	9119+85	9126+66
340	2TS				9203+85	9213+85	9226+66
340	4TS				8604+85	8608+85	NONE
410	4CH				5604+85	5603+85	
505	FT				9103+84	9119+84	9127+66
505	2TS				9203+84	9213+84	9227+66
505	4TS				8604+84	8608+84	NONE
700	FT				9103+85	9119+85	9126+66
700	2TS				9203+85	9213+85	9226+66
700	4TS				8604+85	8608+85	NONE
1000	FT				9103+85	9119+85	9126+66
1000	2TS				9203+85	9213+85	9226+66
1000	4TS				8604+85	8608+85	NONE
1200	2TS				9203+85	9207+85	9226+66
1200	4TS				8604+85	8607+85	
1230	4TS				8604+85	8607+85	
1250	4TS		RE	6006+85		8607+85	
1300	4TS		RE	6006+84		8607+85	
1340	4CH				5604+85	5603+85	
1400	4TS				8604+85	8608+85	NONE
1500	2TS				9203+85	9207+85	9226+66
1500	4TS				8604+85	8607+85	NONE
1600	2TS				9203+85	9207+85	9226+66
1600	4TS				8604	8607+85	NONE
2010	4TS		RP	8607+85			NONE
2020	4TS		RP	8607+85			NONE
2040	4TS		RP	8607+85			NONE
2050	4TS		RP	8607+85			NONE
2070	4TS		RP	8607+85			NONE
2080	4TS		RP	8607+85			NONE
2100	2TS				9203+85	9213+85	9226+66

TEL. 973-579-5773 • FAX 973-579-6021 • email [jrf@jrsmagnetics.com](mailto:jrf@jrsmagnetics.com)



# Reel-to-Reel Tape Heads (cont.)

Model #	Track Style — Reference Notes	RP or RPE	4th Head or Combo	Record Head & QK	Playback Head & QK	Erase Head & QK
<b>TEAC</b>						
2100	4TS			8604+85	8608+85	NONE
2300	2TS			9203+85	9213+85	9226+66
2300	4TS			8604+85	8608+85	NONE
2340	4CH			5604+85	5603+85	
2500	4TS	RE	6006+85		8607+85	
2520	4TS	RE	6006+85		8607+85	
3300	2TS			9203+85	9213+85	9226+66
3300	4TS			8604+85	8608+85	NONE
3340	4CH			5604+85	5603+85	
4010	FT			9103+85	9119+85	9126+66
4010	2TS			9203+85	9213+85	9226+66
4010	4TS - 24			8604+85	8608+85	NONE
4010SRA	4CH			5604+85	5603+85	
4020	4TS	RP	8607+85			NONE
4070	4TS	RE	6006+85		8607+85	
4300	4TS			8604+85	8608+85	NONE
5000	4TS			8604+85	8608+85	NONE
5010	4TS			8604+85	8608+85	NONE
5300	4TS			8604+85	8608+85	NONE
5500	4TS			8604+85	8608+85	NONE
6000	FT			9103+85	9119+85	9126+66
6000	2TS			9203+85	9213+85	9226+66
6000	4TS			8604+85	8608+85	NONE
6010	4TS - 24			8604+85	8608+85	NONE
6100	2TS		8608 (P)	9203+85	9213+85	9226+66
6300	2TS		8608 (P)	9203+85	9213+85	9226+66
7010	2TS			9203+85	9213+85	9226+66
7010	4TS			8604+85	8608+85	NONE
7030 GSL	FT	2TS P	9213+85	9112+85	9119+85	9126+66
7040	4CH			5604+85	5603+85	
7300	2TS			9203+85	9213+85	9226+85
<b>TECHNICS (Panasonic)</b>						
RS-1500-US	S2T	4TS P	8608+93	9203+93	9213+93	9227+93
RS-1506-US	4TS	2TS P	9213+93	8604+93	8608+93	
<b>TELEX (Viking) (Also see Magnacord)</b>						
Studio 96	FT - 25			9105	9111	4400L
Studio 96	2TM - 25			3205	3201	3600L
Studio 96	2TS - 25			2005	9213	2200L
Studio 96	4TS - 25			1205	8608	1400L
Studio 96	FT - 26			9105	9111	4401L
Studio 96	2TM - 26			3203	3201	3601L
Studio 96	2TS - 26			9205	9213	2201L
Studio 96	4TS - 26			1203	8608	1401L
230	FT			9105	9111	4401L
230	2TM			3203	3201	3601L
230	2TS			2003	2001	2201L
230	4TS			1203	1201	1401L

TEL. 973-579-5773 • FAX 973-579-6021 • email [jrf@jrfmagnetics.com](mailto:jrf@jrfmagnetics.com)



# Reel-to-Reel Tape Heads (cont.)

Model #	Track Style — Reference Notes	RP or RPE	4th Head or Combo	Record Head & QK	Playback Head & QK	Erase Head & QK
<b>VEGA</b>						
800	2TS	4TS	8609+76	9204+76	9209+76	9227+76

TEL. 973-579-5773 • FAX 973-579-6021 • email [jrf@jrsmagnetics.com](mailto:jrf@jrsmagnetics.com)

# Nortronics Mounting Hardware and Accessories

Nortronics offers a variety of hardware and mounting accessories for use with replacement heads. These are available from nationwide Nortronics dealers as "off the shelf" items and are detailed below:

## BIAS OSCILLATOR TRANSFORMERS

**T-70 SERIES**  
for p.c. board mounting only

- T70-T2 For Xsistor circuits, 50-120 KHz & 40, 80, or 120 Volts RMS.  
T70-T5 For Xsistor circuits, 150-200 KHz.  
T70-T6 For Xsistor circuits, 230-500 KHz & 70 Volts RMS.

**T-60 SERIES**  
for chassis mounting only

- T60-T2 For Xsistor circuits, 60-110 KHz & 40, 80, or 120 Volts RMS.  
T60-T6 For Xsistor circuits, 230-500 KHz & 70 Volts RMS.

## CONTACTOR HEAD for end-of tape sensing/track switching

- CH-3-N/B Contactor head, no-mount head including base mount adapter  
CH3-R Contactor head, Rear Mount

## QUIK-KIT MOUNTING BRACKETS

- OK-74 **Universal Mounting Bracket.** A unique, general-purpose assembly featuring alignment for head, face and azimuth. Two TG-7 guide posts may be added if desired, or tabs for guide posts may be snapped off for limited space applications. Base features holes for mounting on recorder. For all Nortronics No-Mount Record, Play, Record/Play, and Combo heads except 3000-3299 Series and miniature heads. Also fits special "B" Case Erase heads. Base size with tabs: 1 1/16"W x 1 27/32"L. Base size without tabs: 1 1/16"W x 1 7/32"L.
- OK-75 Identical to QK-74, but two TG-7 guide posts are included.
- OK-76 Mounting hardware to convert many AMPEX nests to Nortronics heads. Includes mounting block with hardware and plug.

QK-75

## OTHER QUIK-KIT MOUNTS AVAILABLE

- |                           |                         |                           |
|---------------------------|-------------------------|---------------------------|
| QK-18 Std. Erase - Side   | QK-86 Ampex 900/600     | QK-97 Revox               |
| QK-19 Std. Erase - Base   | QK-87 Ampex PR-10       | QK-102 "B" Dual-Stud Base |
| QK-20 "G" Case - Side     | QK-88 Magnecord 728     | QK-106 Concertone "B"     |
| QK-21 "G" Case - Base     | QK-89 Scully Adapter    | QK-110 810-045            |
| QK-35 "B" Case - Sp. Base | QK-90 Scully Adapter    | QK-112 810-042            |
| QK-38 "B" Case - Side     | QK-91 Scully            | QK-114 810-055 "B" Cart.  |
| QK-66 "B" Case - Base     | QK-92 Ampex 600         | QK-116 Roberts            |
| QK-73 Electro Sound       | QK-93 Otari             | QK-117 810-066            |
| QK-79 Ampex AG440         | QK-94 Pioneer RT701     | QK-304 Concertone-Erase   |
| QK-84 Concertone          | QK-95 Pioneer 2022      | QK-701 Pioneer RT701      |
| QK-85 Teac                | QK-96 Sony TC650, TC850 | Oscillator                |

## TAPE GUIDE POST

TG-7 Precision guide for positioning and controlling tape path travel. Special chrome-plated brass finish for longest life, minimum wear. Supplied with a variety of mounting hardware.

## PLUG AND CABLE ASSEMBLIES

(CC-77 WIRING)

- CC-70 18" Plug and shielded insulated cable assembly for new model Nortronics heads (except Mono Combo and Cassette heads).
- CC-77 18" Plug and shielded insulated cable assembly for Nortronics Mono Combo and Cassette heads (except 5400 Series).
- CC-110 4" Plug and unshielded cable assembly for Mono heads.
- CC-111 4" Plug and unshielded cable assembly for Stereo heads.

## PIN CLIPS

- TC-54 Gold-plated beryllium copper (supplied in pkgs. of 100). For heads with .050" pins.
- TC-91 Gold-plated beryllium copper (supplied in pkgs. of 100). For heads with .030" pins.

## PIN CLIPS AND CABLE ASSEMBLIES

- |  |   |
|--|---|
| CC-55 9" Terminal Clip and shielded cable assembly (red-orange) 2 per pkg. (for .050" pins only) | CC-78 24" Terminal Clip and shielded cable assembly (red-orange) 2 per pkg. (for .050" pins only) |
| CC-56 As above - coded (yellow-blue)   | CC-79 As above - coded (yellow-blue)  |
| CC-57 As above - coded (white-black)   | CC-80 As above - coded (white-black)  |
| CC-58 As above - coded (red-black)   | CC-81 As above - coded (red-black)  |

1. Epoxy head to bracket.
2. Epoxy head to original plate.
3. Use two playback heads.
4. Ground one side of erase head, connect other side to one erase lead, float other lead.
5. Change erase coupling capacitors C45 and C46 to .02 mfd.
6. Mounting not available.
7. Erase head replacement requires circuit modification.
8. Requires L-5 Bracket.
9. Readjust bias and record currents.
10. Use original head mounting plate.
11. Erase head is Full Track type.
12. Two-track stereo play head.
13. Mount head and OK inside Original Head Cup.
14. AG-300/350 require erase circuit modification with 9127 FT head. Short 4L2 coil, and add shunt .01-mfd. across 4C37.
15. To adjust new erase head voltage or current to spec. value, raise or lower size of the erase coupling capacitor.
16. New spacer blocks required when replacing LIPPS heads. Order one QK-89 for record head, one QK-89 for erase head, and one QK-90 for play head.
17. Add 1-mH 150 mA min. r.f. choke in series with each coil of erase head and adjust for spec. voltage or current at head. (Per Form 7307 instructions.)
18. Machines with 6V6 Bias Oscillator use for Record Head the same as the Play Head. Listing is correct as is for 6SN7 Oscillator.
19. Erase head for Older Models with Side-Mount Erase Head should be #2201 plus QK-18.
20. For AG-300/350 with single-screw-mount erase head, order also one set of SP-76 Spacer Plates for insertion between QK-76 and cup. See Form 7349 instructions.
21. AG-600, AG-600B, AG-500, AL-500, with 9227 erase head, add 1500-pf. 5% across C28 erase coupling capacitor located on S4. See Form 7355 instructions.
22. AG-600, AG-600B, AG-500, and AL-500, with 8640 erase head, replace C28 (located on S4) with 910-pf. 5% cap., per Form 7355 instructions.
23. Head shown in "RP" column may be used for playback in fourth head position.
24. Connect .001-mfd. capacitors across record head coils, if necessary, to increase adjustment range of bias potentiometers.
25. Serial No.'s below 96-280.
26. Serial No.'s above 96-280.
27. Special 4-head nests require QK-87 mounts in place of QK-76. Fourth head model shown in RP column.
30. Full-track erase head shown. For selective 4-channel erase, use instead two 8640 stereo 4-track erase heads with two QK-87 mounts.
31. AMPEX 3200 duplicator for cassette tape requires new tape guides. W-size cassette slave heads need shims to fit QK-76 mount.
32. AMPEX 952, 954, 960, 4-track stereo recorder with dual-coil bias oscillator secondary. Requires replacement of original bias oscillator transformer with new Nortronics T60-F when replacing erase head, because original transformer has poor voltage regulation. (See Drawing No. 725B001 (with QK-86) for instructions.)
33. Use bracket from original head to mount new head.
34. A77, mount new head on head plate, drilling new mounting hole, if necessary, for correct position. Cut slot in bottom of head shield-can, from mounting hole to rear edge, to permit it to be slid over head.
35. 36 series, mount new head inside shield-can, from top of can. Bend cable sharply, near pins, to clear inside of can.
36. The QK-91 SCULLY mount is re-usable and needs to be installed only once. Check present head mount; if it has a set screw holding head in its bracket, then the QK-91 is not needed. To help remove old head, heat bracket with soldering iron to soften epoxy cement.
37. AMPEX 602 series needs QK-86 on later models with oval brass head plate held with slot-head screws. Earlier machines may have threaded studs on brass head plate held by lock-nuts, these require QK-92 instead of QK-86.
38. 100 Series SCULLY machines have dual-head nest with one RP and one erase head. Order complete RPE assembly, or separate RP or Erase heads as needed.
39. Fixed-head SCULLY 270-44 machines with electronics switching can use the 5603 4-channel play heads.
40. QK-88 mount needed only when replacing the one-piece cylindrical heads.
41. Add 2.5-mH r.f. choke in series with each channel of 8640 erase head to limit head voltage to 25-30v. rms at 100 kHz.
42. Conversion of RT-701 to 2-track or Full-track heads requires one QK-701 (T70-T22) booster erase oscillator in addition to heads and mounts. (See Form 7395 instructions.)
43. Add 0.5-mH 150 mA min. r.f. choke in series with each coil of erase head to give correct impedance match. Verify correct head voltage and current.
44. Order Form #7394 from RCD Division of Nortronics; describes how to mount heads on MUZAK tape players.

## ABBREVIATIONS USED IN THIS CATALOG

FT	Full Track, 1/4-inch	R MAS	Reel Master
2TM	Two-Track Mono	CAS MAS	Cassette Master
2M	Two-Track Mono	C-C	Cassette-to-Cassette Duplicator
2T	Two-Track, Two Channel	CAS SL	Cassette Slave
2TS	Two-Track Stereo	R SL	Reel Slave
2S	Two-Track Stereo	1/4" R-C	1/4-inch Reel-to-Cassette Duplicator
4TS	Four-Track Stereo, 1/4-inch	1/4" R/C-C	1/4-inch Reel and Cassette Master to Cassette Slave
4CH 1/2"	Four-Channels on 1/2-inch Tape	CAS R-R	Cassette 150-mil Reel-to-Reel
4CH 1/4"	Four-Channels on 1/4-inch Tape	4TS CAS	4-Track Stereo Cassette
8TS	8-Track Stereo, 1/4-inch Tape	2TM CAS	2-Track Mono Cassette (Single-Ch. Head)
8TO	8-Track Quadraphonic (4-Ch.)	4CH 4T	Four Channels of 4-Track System on 1/4-inch Tape
8T 1/4"	8-Channels on 1/4-inch Tape	2CH 4T	Two Channels of 4-Track System, similar to 4-Track Stereo
8CH 1"	Eight Channels on 1-inch Tape	C SL	Cassette Slave
12CH 1"	Twelve Channels on 1-inch Tape	C MAS	Cassette Master
16CH 2"	Sixteen Channels on 2-inch Tape	CR SL	Cassette Reel Slave
24CH 2"	24-Channels on 2-inch Tape	S CAS	Stereo Cassette (4-Track)
4CH CAS	Four Channels on Cassette Tape (4-Ch. Head)	S NAB	Stereo, NAB, Broadcast, 2 Program plus 1 Cue (3-Ch.)
4T CAS	Four Channels on Cassette Tape (4-Ch. Head)	M NAB	Mono, Broadcast, 1 Program plus 1 Cue (2-Ch.)
2T CAS	Two Channels of Mono on Cassette Tape (2-Ch. Head)		
1/4" R-R	1/4-inch Reel-to-Reel. (Duplicator)		



# HEAD OUTLINES

NOTE: DIMENSIONS ARE SHOWN IN INCHES OVER MILLIMETERS.

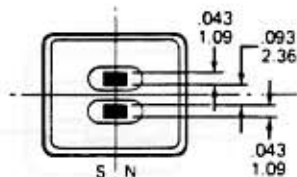

**1B 1200/PB2Q**

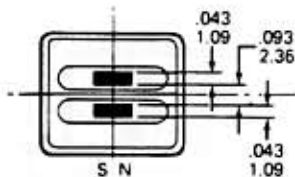

**2B 8600/WPB2Q**

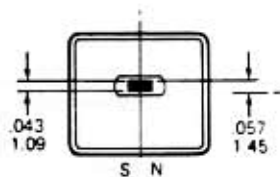

**3B 7610/PB1QY**

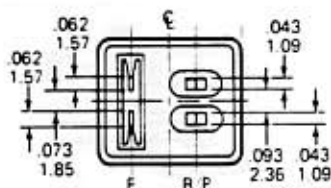

**4B 6000/PA2Q**

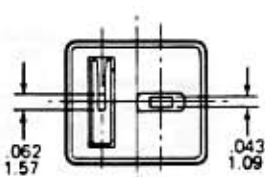

**5B 6026/A1QC**

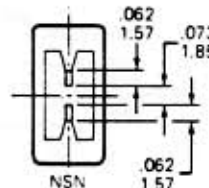

**6SE 1400/SSEQ**

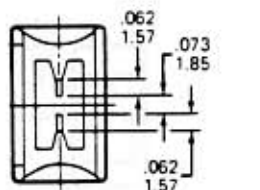

**7LE 1400L/LSEQ**

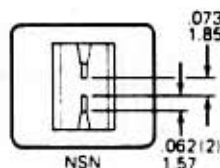

**8B 8701/B2EQ**

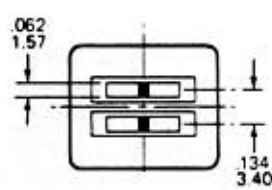

**9B 8640/PRB2EQ**

.100 TRACK SPACING  
2.54 CENTER TO CENTER

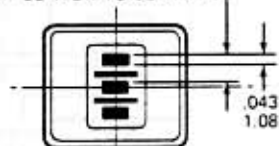

**10B 5700/PB3Q**

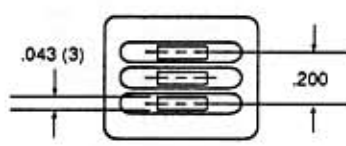

**11B 5703D/LFPR3Q**

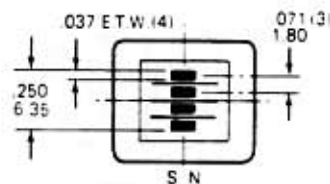

**12B 5600/BQQ**

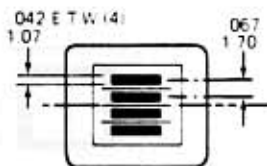

**13B 5630/B4Q**

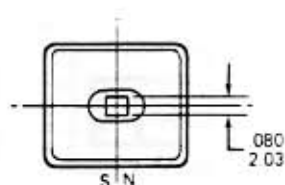
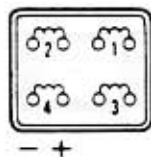

**14B 7414/B1HC**

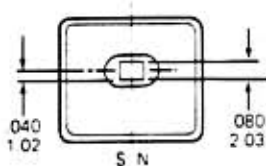

**15B 8401/PB1HY**

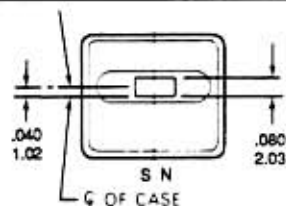

**16B 8400/WPB1HY**

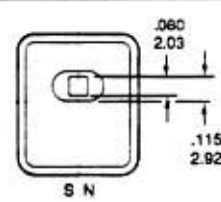

**17G 3200/PG1H**

# HEAD OUTLINES

NOTE: DIMENSIONS ARE SHOWN IN INCHES OVER MILLIMETERS.

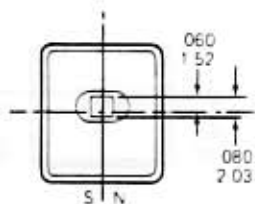

**18G 3100/G1HY**

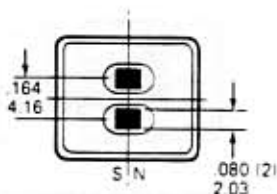

**19B 2000/PB2H**

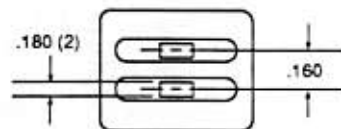

**20B 2030/LFPR2H**

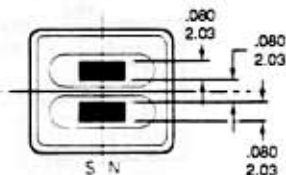

**21B 8200/WPB2H**

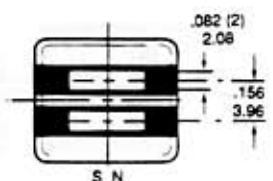

**22B 9200/PRB2H**

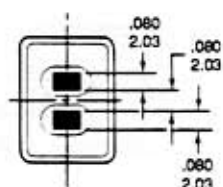

**23C 7251/PC2H**

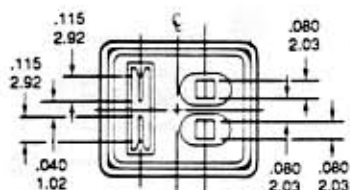

**24B 6100/PA2H**

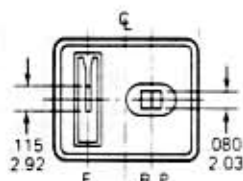

**25B 6126/PA1HC**

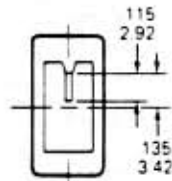

**26SE 3600/SMEH**

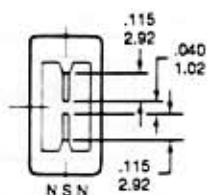

**27SE 2200/SSEH**

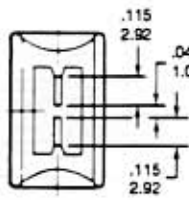

**28LE 2200/LSEH**

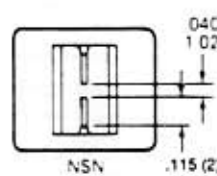

**29B 8301/B2EH**

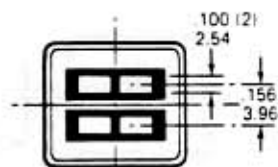

**30B 9222/PRB2EH**

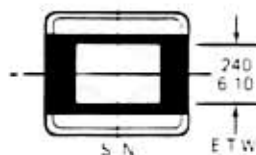

**31B 9102/PRB1F**

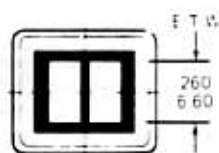

**32B 9125/PRB1EF**

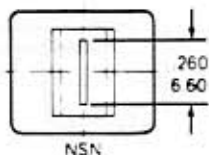

**33B 8101/B1EF**

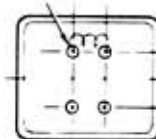

**COIL TO UPPER PINS**

# HEAD OUTLINES

NOTE: DIMENSIONS ARE SHOWN IN INCHES OVER MILLIMETERS.

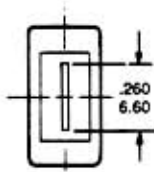

**34SE 4400/SMEF**

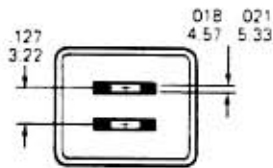

**35B 5800/B2L**

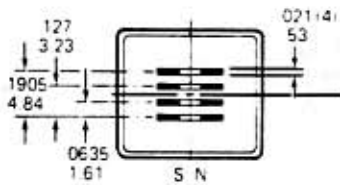

**36B 5830/BQL**

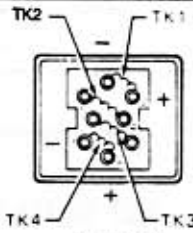

**P-BQL**

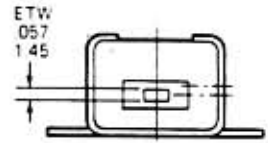

**37W 5130/W1R**

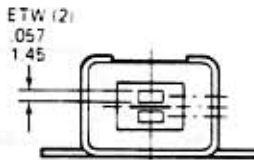

**38W 5200/W2P**

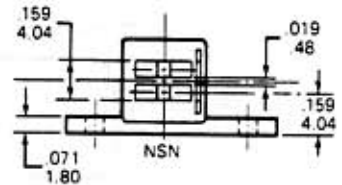

**39W 5210/W2ER**

## "A" MOUNT STYLE

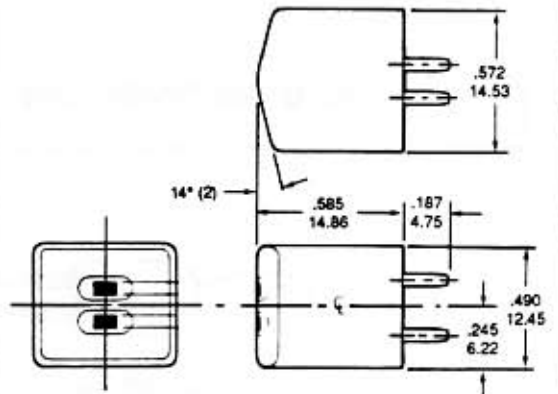
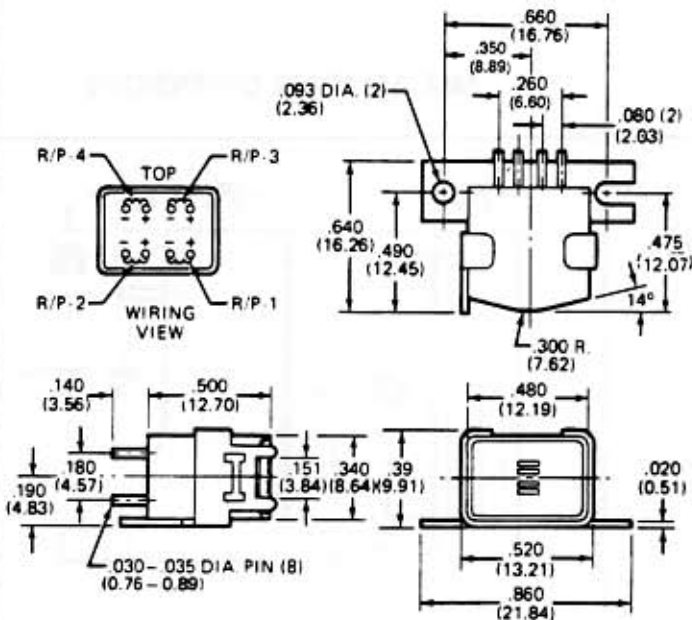

**41B "B" SIZE DIMENSIONS**

# HEAD OUTLINES

NOTE: DIMENSIONS ARE SHOWN IN INCHES OVER MILLIMETERS.

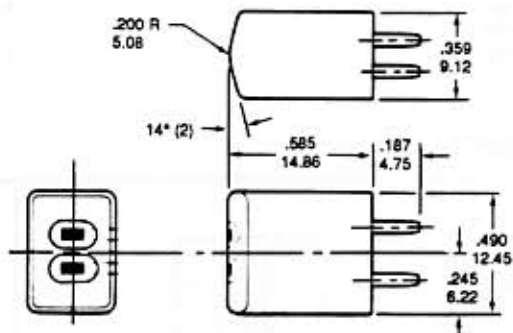

42C 'C' SIZE DIMENSIONS

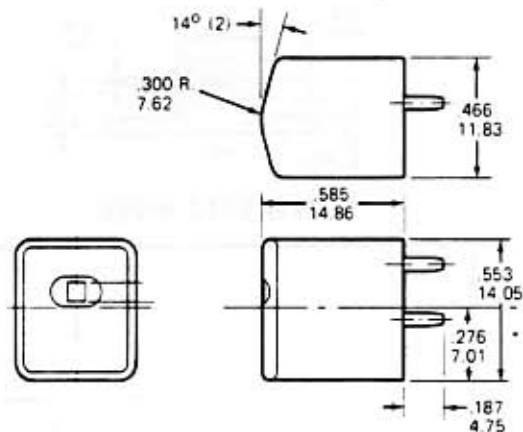

43G 'G' SIZE DIMENSIONS

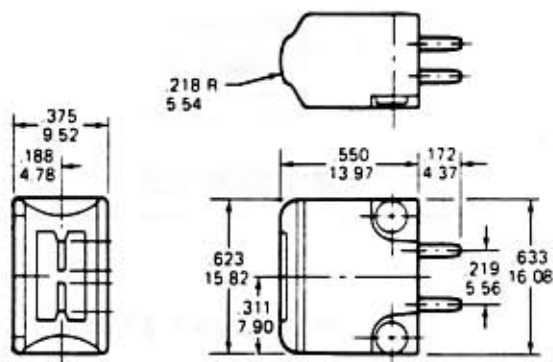

44LE 'LE' ERASE DIMENSIONS

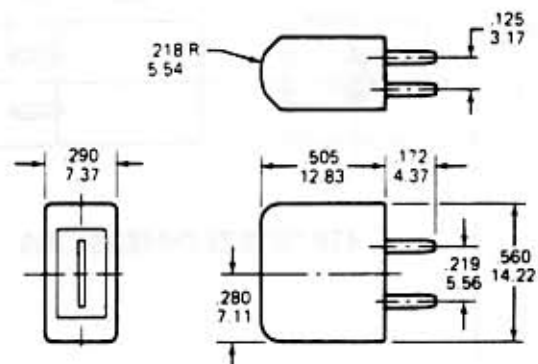

45SE 'SE' ERASE DIMENSIONS

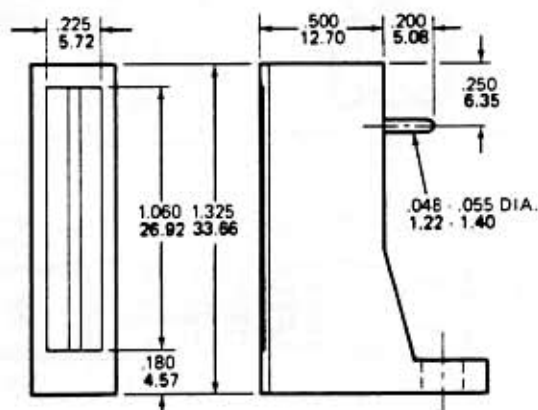

46RX 7721/REX-101

# HEAD OUTLINES

NOTE: DIMENSIONS ARE SHOWN IN INCHES OVER MILLIMETERS.

## TYPICAL REAR MOUNT

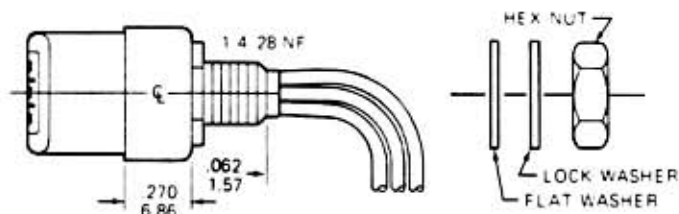

1 RED-ORG  
2 YEL-BLU

Stereo Heads  
1200/2000 etc.  
B2Q/B2H/SEH

### ERASE R/P

1 BLK-WHT RED-ORG  
2 BRN-GRN YEL-BLU

COMBO 6100/A2H/A1HC  
(Mono Use #1)

1 BLK-RED  
2 BRN-ORG

3 GRN-YEL  
4 WHT-BLU

5600/5830  
BQQ/BQL

1 RED-ORG  
2 YEL-BLU  
3 WHT-BLK

5700/B3Q

## REAR MOUNT LEADS - COLOR CODE

## 47 REAR MOUNTS

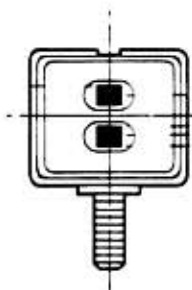

### SINGLE 6-32 STUD

(.200 inch back from from head face, spot welded to spring clip.)

QK-19 "SE" Erase Heads  
QK-21 "G" Size R/P Heads  
QK-66 All "B" Size Heads

## 48 BASE MOUNT QUIK-KITS

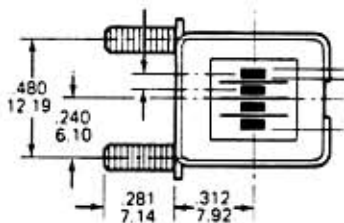

### TWO 2-56 STUDS

(On side of spring clip.)

QK-18 "SE" Erase Heads  
QK-20 "G" Size R/P Heads  
QK-38 All "B" Size Heads

## 49 SIDE MOUNT QUIK-KITS